

Mathematica Centrum

Together, let's shape the mathematicians of the future

LAGRANGE PREPARATORY TEST 2023

- What is the sum of -8 and the opposite of 8?
A) 8 B) -16 C) 0 D) -8 E) 16
- Which of the following is closest to $\sqrt{100} + \sqrt{81} + \sqrt{9}$?
A) 20 B) 21 C) 22 D) 23 E) 24
- The remainder of $2023 \div 2020$ is
A) 0 B) 1 C) 2 D) 3 E) 4
- The difference between two prime numbers is 9. What is their sum?
A) 13 B) 14 C) 15 D) 16 E) 17
- The result of $(-4 + 8) \times 5(5 - 2)$ is
A) 60 B) 90 C) 120 D) 160 E) 140
- What is the value of M in the equation: $6 \times 7 \times 8 \times 9 \times 10 \times 11 = 8 \times 9 \times 10 \times M \times 2 \times 11$?
A) 14 B) 21 C) 16 D) 18 E) 7
- Forty percent (40%) of the 80 students in a classroom are girls. How many boys must leave the classroom so that the girls represent 50% of the students left in the classroom?
A) 5 B) 10 C) 15 D) 20 E) 16
- Andrea has written 18 consecutive integers in decreasing order. If the largest is 12, what is the smallest?
A) -8 B) -7 C) -5 D) -9 E) -6
- An electric car uses 3 kWh (3 kilowatt-hours) of energy to cover 20 km. With 15 kWh it will cover approximately
A) 100 km B) 64 km C) 74 km D) 83 km E) 79 km

10. ABC is a right triangle (the measure of angle ABC is 90°). What is the perimeter of triangle ABC if $BC = 5.2$ cm and $DC = 3$ cm?

- A) 15.8 cm B) 11.8 cm C) 13.9 cm
 D) 14.2 cm E) 13.8 cm

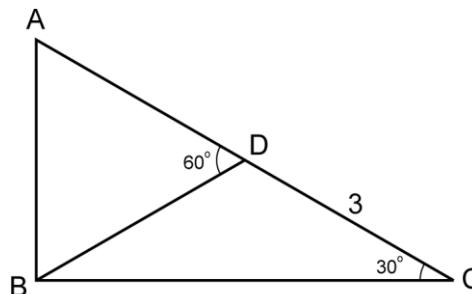

11. Which of the following fractions is the average of $1/3$ and $1/4$?

- A) $1/2$ B) $7/24$ C) $10/24$
 D) $3/8$ E) $8/24$

12. The sum of all the factors of 10 is equal to

- A) 11 B) 12 C) 14
 D) 15 E) 18

13. Nine blocks have been glued together, as shown in the diagram. How many faces of these blocks have glue on them?

- A) 19 B) 20 C) 22
 D) 24 E) 18

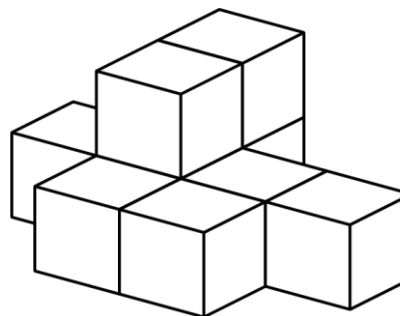

14. What is the value of N in the equation: $2/7 \times N = 3/21$?

- A) $4/3$ B) $3/2$ C) 1
 D) 3 E) $1/2$

15. Line segment OB is rotated 90° about centre O. The coordinates of point B after the rotation are

- A) (3, -6) B) (-6, -3)
 C) (-6, 3) D) (6, -3)
 E) (-3, -6)

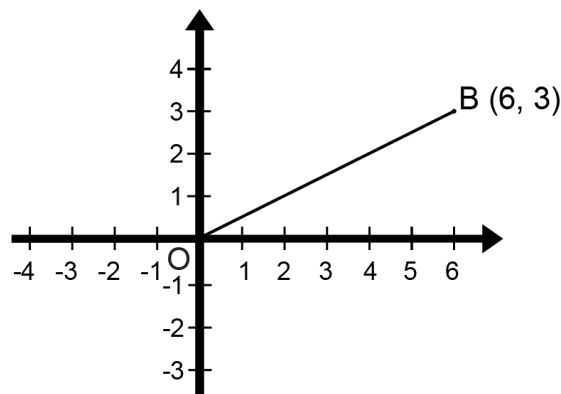

16. One litre of liquid A has 25% more calories than 1L of liquid B. How many calories does 1L of liquid B contain, if 1L of liquid A contains 600 calories?

- A) 960 calories B) 1 200 calories C) 480 calories
 D) 1 100 calories E) 920 calories

17. Each small square in the grid has an area of 1 cm^2 . What is the area of the concave pentagon shown in the diagram?

- A) 10 cm^2 B) 8 cm^2 C) 9 cm^2
 D) 13 cm^2 E) 7 cm^2

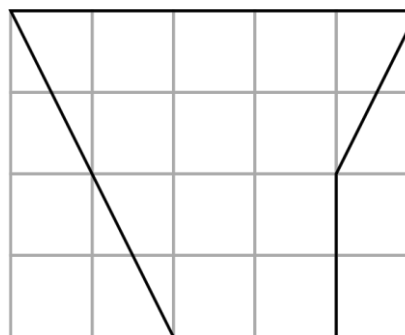

18. Which of the following is not a perfect cube?

- A) 125 B) 8 C) 27 D) 81 E) 64

19. If $1^2 + 2^2 = 2 + 3$, $3^2 + 4^2 = 12 + 13$, $8^2 + 9^2 = 72 + 73$, what is the value of $P^2 + Q^2$, if P and Q are two consecutive natural numbers?

- A) $P \times Q + Q$ B) $2 \times P \times Q$ C) $P \times Q + 1$
 D) $P \times Q - 1$ E) $P \times Q + P \times Q + 1$

20. If $ED = DC$ and $CB = 2EC$, the area of triangle ABD is how many times larger than the area of triangle EAC?

- A) 2 times B) 4 times C) 2.5 times
 D) 5 times E) 6 times

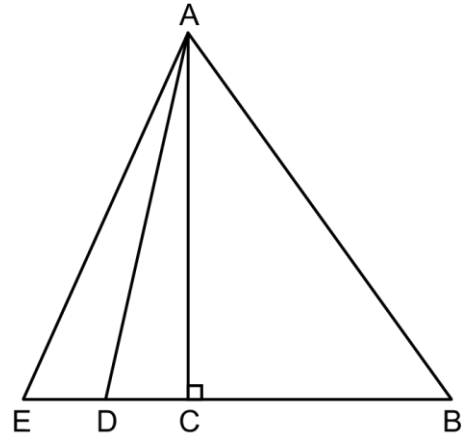

21. Which of the inequations below is false?

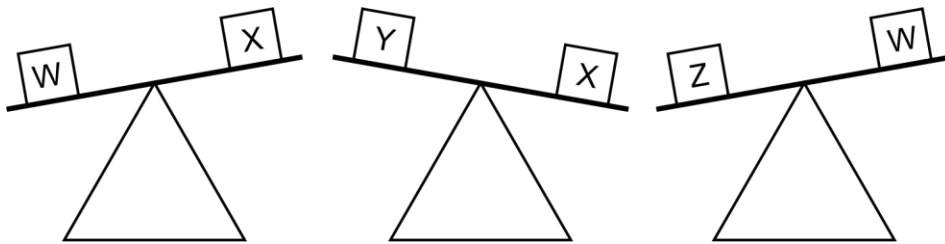

- A) $Z > X$ B) $W > X$ C) $X > Y$
 D) $Y > W$ E) $Z > W$

22. A high speed train is moving at 80 m/s. Which of the given speeds is equivalent to 80 m/s?

- A) 288 km/h B) 2.4 km/h C) 3 600 m/h
 D) 2 400 m/min E) 140 km/h

23. Look at the triangle. The value of $X + 50^\circ$ is equal to

- A) 125° B) 110° C) 75°
 D) 95° E) 105°

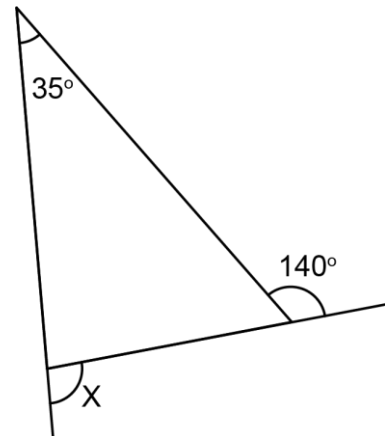

24. What is the product of the LCM and the GCD of 4 and 9?

- A) 36 B) 6 C) 8 D) 10 E) 1

25. The ones digit of 9^{33} is

- A) 0 B) 1 C) 9 D) 3 E) 4

26. ABCD is a large square divided into 9 smaller squares. How many 1 x 2 and 1 x 3 rectangles can you count in the diagram?

- A) 20 B) 22 C) 18
 D) 24 E) 25

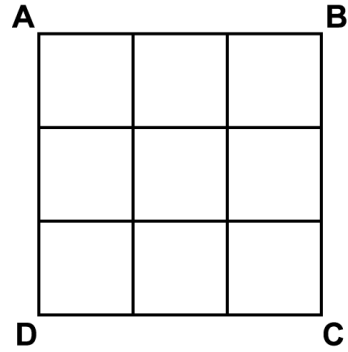

27. Which of the answers below represents a congruency with a remainder of 5?

- A) $18 \equiv 25 \pmod{7}$ B) $17 \equiv 7 \pmod{10}$ C) $8 \equiv 15 \pmod{7}$
 D) $7 \equiv 21 \pmod{7}$ E) $5 \equiv 17 \pmod{12}$

28. The points in a network are called vertices and the curves or straight lines are called arcs. The second network from the left has 8 vertices. The number of arcs meeting at a vertex is extremely important. If an even number of arcs meet at a vertex, we say that the vertex is even. If an odd number of arcs meet at a vertex, we say that the vertex is odd. As you can see, the second network has all even vertices. Four vertices have 2 arcs meeting at them and four vertices have 4 arcs meeting at them. Notice that the first network has two even vertices. The third network has 6 vertices, 4 even ones and 2 odd ones. The last network has 4 vertices, 2 even ones and 2 odd ones. If you can start at a certain vertex, follow a path through all the network and end at the same or another vertex in a way that each arc is traversed exactly once (you cannot go over the same arc more than once), we say that the network is traversable. A network that is traversable in a way that the starting vertex is the same as the stopping vertex is called a Euler circuit or Eulerian circuit. Go through the first network. Notice that you can start at any of the two vertices; go through all the network (never going over an arc more than once), you will end up at the same vertex where you started. Networks that have only even vertices are always Eulerian circuits. Also, verify that the second network is a Eulerian circuit. The other two networks are traversable networks but are not Eulerian circuits. They are called Euler paths. Euler paths start and end at different vertices. Verify that the last two networks are Euler paths.

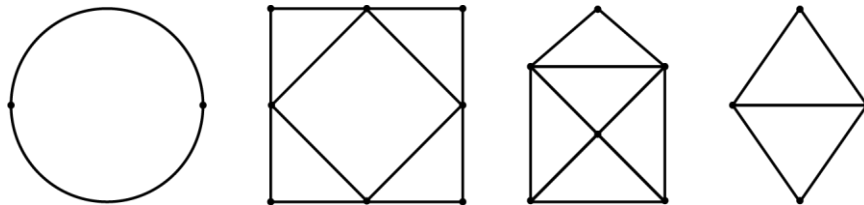

How many of the networks shown below are Eulerian circuits?

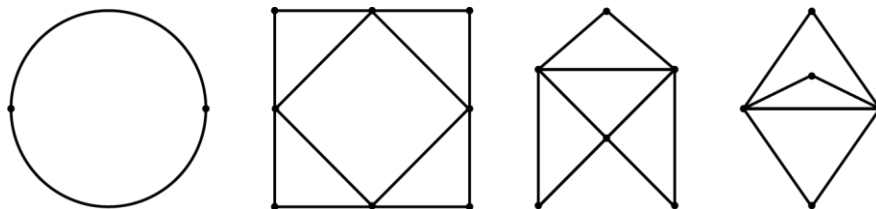

- A) 1 B) 2 C) 3 D) 4 E) 0

29. If $X = 2Y$ and $3X + 2Y = 40$, what is the value of $3X + 5Y$?

A) 64

B) 58

C) 55

D) 65

E) 51

N.B. The figure in number 17 is a concave pentagon and not a convex pentagon.